

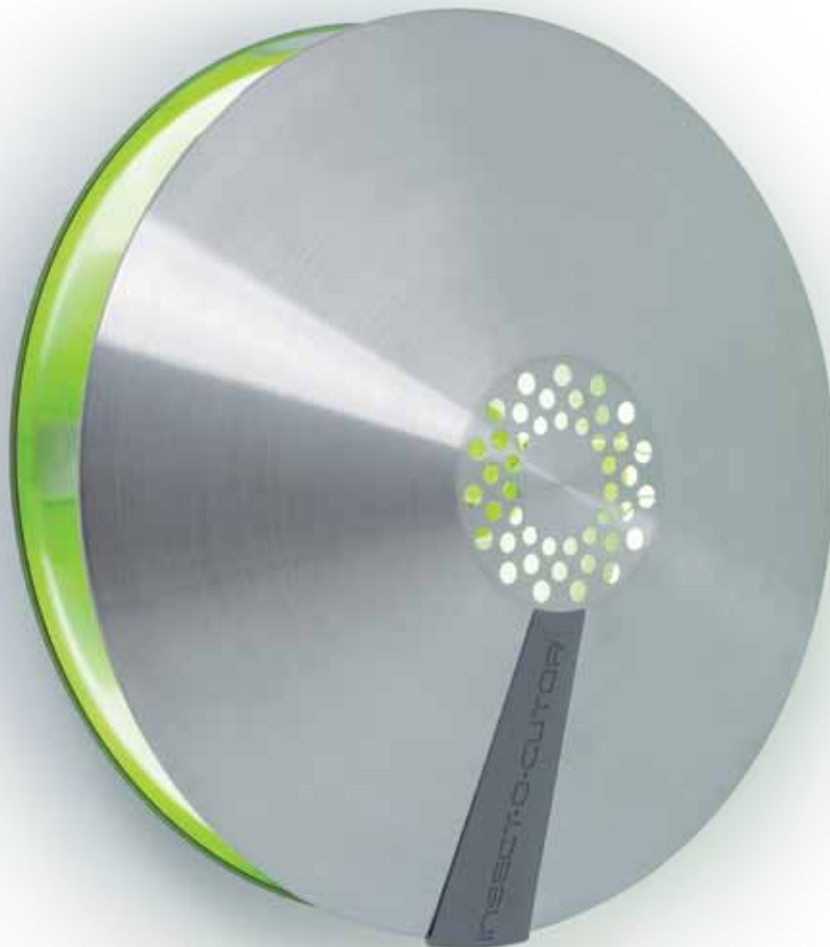

Stylish and contemporary, the Aura™ decorative flykiller is an ultra discreet unit designed for front-of-house applications.

Ideal for use within cafes, restaurants, bars and hotels, the Aura™ offers an elegant, modern aesthetic alongside innovative, easy-to-service features and maximum efficacy. **The unique circular registered design of the unit allows light to attract flying insects from a full 360° around the unit**, attracted by the patented Synergetic® green light, whilst the design of the discreetly positioned glueboard gives a 100% useful glue area which remains hidden from customer view.



FEATURES

- Contemporary detailing and elegant clean lines
- Beautifully polished facade
- Slim design ensures that the unit is unobtrusive
- Ultra discreet fly catching glueboard hidden from view
- 100% useful glueboard area ensures maximum efficacy
- Ensures compliance with food hygiene legislation and protects clientele from flying pests
- Patented dual wavelength Synergetic® technology for an increased catch
- Easy tool free access and efficient servicing
- Quick and simple IEC mains socket, or discreet hard wiring option
- Robust stainless steel and UV stable polycarbonate construction

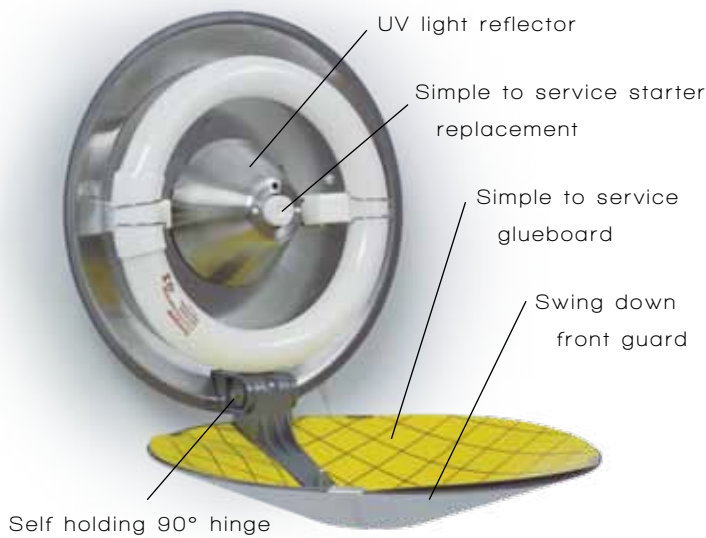

PRODUCT CODE	ZL051
DESCRIPTION	Aura, 22 Watt
DIMENSIONS (MM) H x W x D	270 x 270 x 135
COVERAGE (M ²)	40
TUBES	1 X TGX22
GLUEBOARDS	1 x INL198
WEIGHT (KG)	1.9



ROOM COVERAGE

40 m²

APPLICATION

Front of House

Professional Glueboard Insect Control

Please read these instructions carefully and store in a safe place for future reference.

Aura™

As part of the **Insect-O-Cutor®** brand of insect control products, **Aura™** is a decorative professional flykiller which utilises a highly effective **Synergetic®** UV tube and is designed for use with a high specification **glupac®** glueboard.

CONTENTS OF PACKAGE

- 1 x Aura™ flykiller
- 1 x **glupac®** pheromone impregnated glueboard
- 1 x Mains cable (Type X)
- 1 x High powered **Synergetic®** UV tube (Fitted)
- 2 x Screws and wall plugs
- 1 x Hard wired blanking piece

WARNING - THIS APPLIANCE MUST BE EARTHED (CLASS 1)

INSECT CONTROL PRODUCTS

Aura™ utilises a high powered ultra violet tube to attract flying insects and retains the caught insects on a pheromone impregnated glueboard for inspection or hygienic disposal.

WARNING

Aura™ is not to be used by children or persons with reduced physical, sensory or mental capabilities, or lack of experience and knowledge, unless they have been given supervision or instruction.

Children should be supervised to ensure they do not play with the appliance.

If the mains cable is damaged it must be replaced by a specialist mains cable available from Pelsis Ltd or your supplier.

POSITIONING AND GUIDANCE FOR USING AURA™

THIS UNIT IS FOR INDOOR USE ONLY.

For most species of flying insects, **Aura™** should ideally be fixed around two meters above the ground, preferably in the darkest place within the area to be protected. Do not position the unit close to windows, skylights or other sources of light, or where it may be obscured by furniture, doors or other obstacles. Ideally, **Aura™** should be visible from every part of the area to be protected.

However, due to its unique circular design, **Aura™** can also be mounted low to the ground, ideal for catching drain flies without revealing the caught insects to customers.

Aura™ should ideally be in operation for 24 hours a day, ensuring your premises are kept free of flying insects. Insects are most attracted to **Aura™** at night when there is no competition from daylight or other light sources.

GUARANTEE

Aura™ has a two year guarantee and if maintained as recommended in these instructions should continue to work for many years.* Use of non-approved consumables may invalidate the guarantee. Ensure genuine **glupac®** glueboards are used in conjunction with this product.

*Excludes tube, glueboard and starter. Does not cover breakdown due to misuse, incorrect operation or use in an incorrect application.

INSTALLATION

INSTALLATION SHOULD BE CARRIED OUT BY SERVICE PERSONNEL ONLY, AFTER ENSURING THAT THE UNIT IS DISCONNECTED FROM THE MAINS SUPPLY.

Aura™ has a swing down front guard for easy access to replace the **Synergetic®** UV tube, **glupac®** glueboard and starter. **Aura™** can either be wall mounted by using the two supplied wall screws or simply located horizontally on a desk.

If wall mounting **Aura™**, either simply use the supplied removable IEC mains cable to plug into the nearest power socket, or use the discreet hard wiring option to provide power directly from a fixed power supply.

BEFORE HARD WIRING, ENSURE THE MAINS POWER SUPPLY IS SWITCHED OFF.

For hard wiring, first mark the two fixing points using the 'Hard Wired Wall Mount Template' on the enclosed sheet, before installing the wall plugs and fixing screws. Remove the front metal plate of the product by unscrewing the three retaining fixing screws. **(fig 1)** Then remove the three short connection wires which connect the IEC socket to the terminal block by pressing the three spring retainers. **(fig2) & (fig 3)** Cover the redundant IEC socket with the supplied blanking piece. **(fig 4)** Next, carefully remove the 'knock out' section of the plastic backplate with a knife, creating the hard wired mains entry port. **(fig 5)** Offer the unit up to the two wall screws and feed the mains wire through the newly created entry port. **(fig 6)** Insert the live, neutral and earth wires into the appropriate spring retainers. **(fig 7)** Finally replace the front metal plate, **(fig 8)** before swinging the front guard back in position. **(fig 9)**

CLEANING

CLEANING SHOULD BE CARRIED OUT BY SERVICE PERSONNEL ONLY, AFTER ENSURING THAT THE UNIT IS DISCONNECTED FROM THE MAINS SUPPLY.

It is recommended that cleaning is carried out regularly when the glueboard is replaced. Once the **glupac®** glueboard is removed, the unit should be thoroughly wiped down with a damp cloth, removing any build up of dirt. Ensure the unit is completely dry before reconnecting it to the power supply.

MOUNTING FIXING CENTRES

METHOD	Aura
Wall	80mm
Desk	-

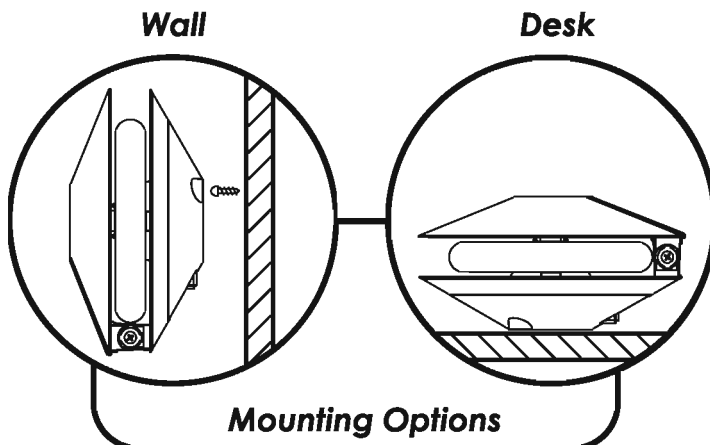

INSECT-O-CUTOR®

GLUEBOARD REPLACEMENT

BEFORE REPLACING THE GLUEBOARD, ALWAYS ENSURE THAT THE UNIT IS DISCONNECTED FROM THE MAINS SUPPLY.

The glueboard should be replaced every month with a genuine glupac® glueboard. Use of non-approved glueboards may invalidate your guarantee. **Aura™** comes supplied with a high specification yellow glueboard with printed grids for simple insect evaluation and monitoring.

To replace the glueboard...

1. Swing down the front guard.
2. Remove the used glupac® glueboard by carefully pulling it clear of the unit.
3. Remove the protective release paper from the new glupac® glueboard.
4. Maneuver the straight edges of the flat glueboard into the gap between the horizontal guard and the vertical tube chassis.
5. Then maneuver the glueboard together to form a conical shape and position the glueboard under the 'front' two metal retaining clips.
6. Finally, tuck the two cardboard 'corners' of the glueboard under the 'back' two metal retaining clips.

Always ensure the selected genuine glupac® glueboards are compatible with your unit, available from your pest control operator or Pelsis Ltd.

TUBE REPLACEMENT

TUBE REPLACEMENT SHOULD BE CARRIED OUT BY SERVICE PERSONNEL ONLY, AFTER ENSURING THAT THE UNIT IS DISCONNECTED FROM THE MAINS SUPPLY.

To ensure the efficiency of **Aura™** in catching flying insects, the UV tube should be replaced annually. After twelve months the phosphor coating that emits the correct wavelength of UV light has burnt away and the UV output is diminished substantially.

To replace the UV tube...

1. Swing down the front guard.
2. Unclip the wire tube clips.
3. Pull the tube away from the chassis.
4. Dispose of the used UV tube in conjunction with local WEEE regulations.

STARTER REPLACEMENT

STARTER REPLACEMENT SHOULD BE CARRIED OUT BY SERVICE PERSONNEL ONLY, AFTER ENSURING THAT THE UNIT IS DISCONNECTED FROM THE MAINS SUPPLY.

The starter provides an extra spark to initially light the UV tube. The starter wears out and should be replaced at the same intervals as the UV tube.

To replace the starter...

1. Rotate the starter anti-clockwise.
2. Pull the starter free from the unit.

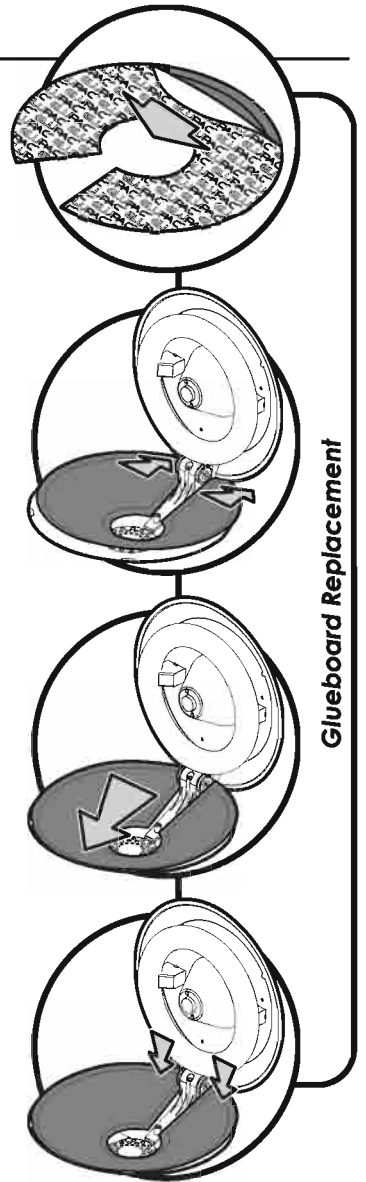

Glueboard Replacement

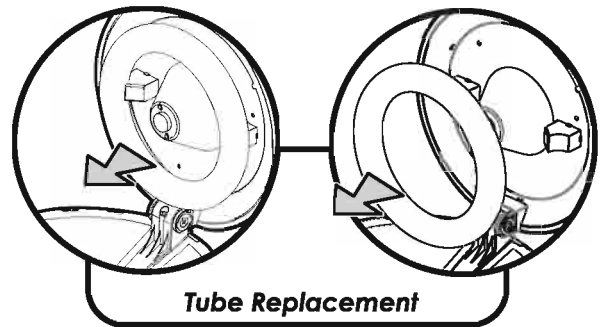

Tube Replacement

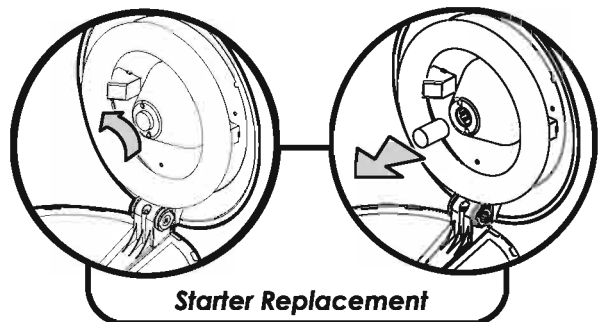

Starter Replacement

SPECIFICATION / REPLACEMENT PARTS

Unit	Aura™
Voltage	230V ~ 50Hz
Dimensions(mm)	270 x 270 x 135
Coverage	40 Sq. Meters
Weight	1.9 Kg
Light Output	22W
Tubes	1 x TGX22
Starter	1 x I154
Glueboards (x6)	INL198 (Yellow)



INVESTORS
IN PEOPLE

Information provided on these instructions is modified and updated from time to time. This is due to the constant redevelopment of our products. As such, it is not intended that you should rely on it or that it should form part of any contract.

Hard Wired Wall Mounting Template

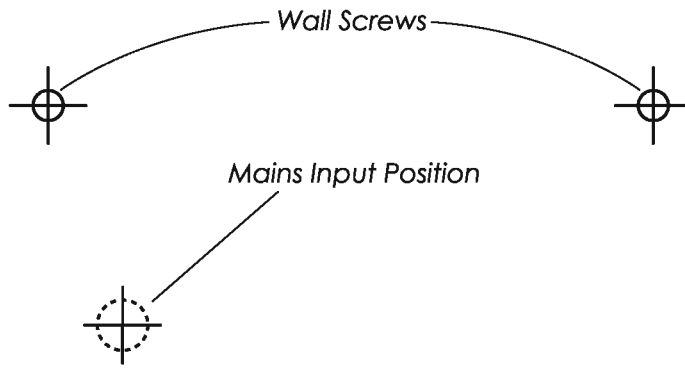

Hard Wired Wall Mounting Guide

